

Summary:

1. Requirements	2
2. Download and setup.....	3
3. Use	5
4. Create a new configuration	7
5. Save a configuration	19
6. Load a configuration.....	20
7. Read a configuration from the Keybox.....	21
8. Program the Keybox with a new configuration.....	23
9. Update firmware	26
10. Keybox electrical specifications.....	32
11. Connection Diagram	34
Appendix: how to connect the Keybox to PC by the Blink RS485-USB adapter	36
12. Revision history	38

1. Requirements

- PC based on WINDOWS operating system (WINDOWS 10 recommended¹).
- DC power supply (12V / 24V).
- KVASER / PEAK CAN-USB adapter or RS485-USB interface.
- Blink RS485-USB adapter orderable on request².
- Keybox.
- Keypads to be used in combination with the Keybox.

¹ With older WINDOWS versions the firmware update procedure might not work!

² See *Appendix: how to connect the Keybox to PC by the Blink RS485-USB adapter* for further details.

2. Download and setup

1. Download the last release of the BlinkKeyboxConfigurator_Installer file from the link provided.
2. Run the installer and follow the setup instructions.

Note: Windows might prevent the procedure by showing the following message:



In such case, click on the buttons signaled by the arrows.

3. After reading the End-Use License Agreement (EULA) tick on *I agree to the license terms and condition*

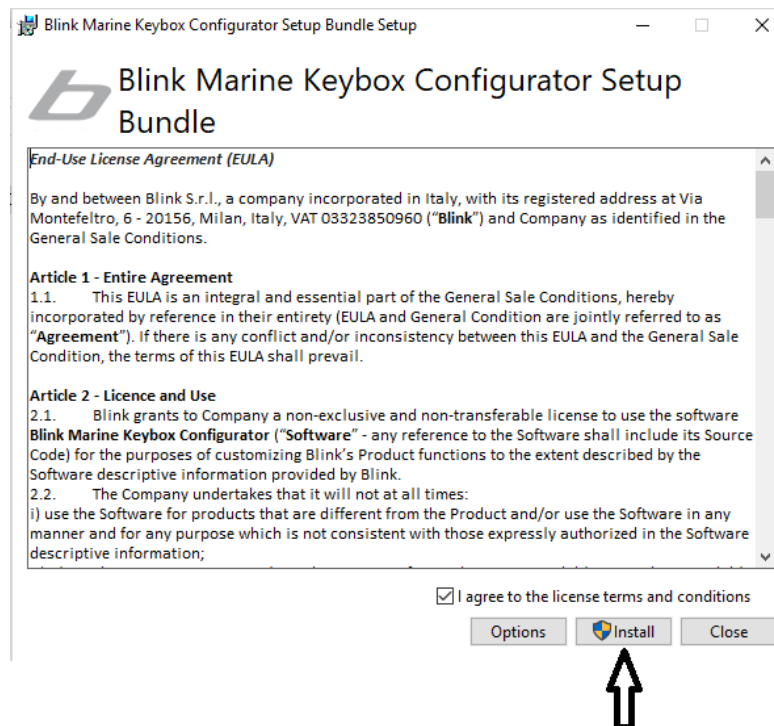

Click on the button Install.

4. Click on the button Install as shown above.
In this case, a popup alert asks to make changes to the own device press YES.

5. After a few instants if the procedure is successful, it should appear the following window:

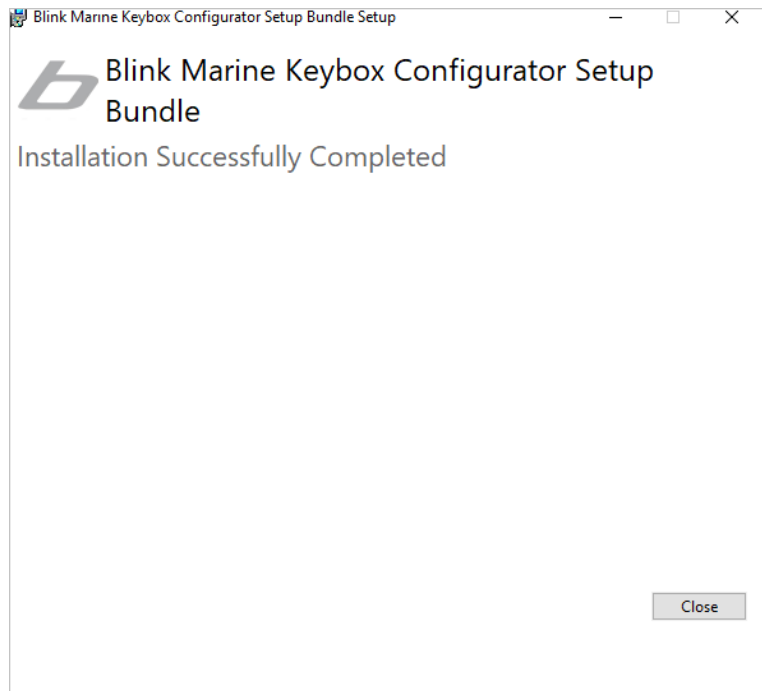

6. The Configurator is ready for use.

3. Use

1. To run the program, double-click on the icon on your desktop:

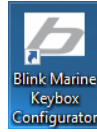

2. When you open the app, you will get the home screen with the main menu as summarized here below:

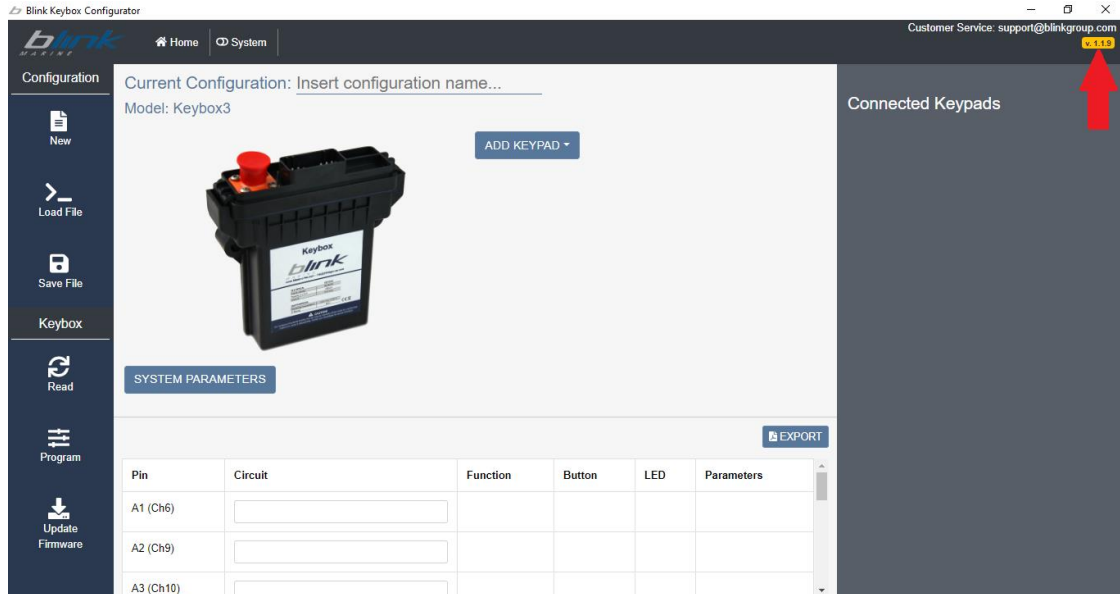

Note: the number at the top right of the home page (highlighted by the red arrow) indicates your current Blink Keybox Configurator version.

Items on the left side

Configuration Menu:

- NEW: to start a new configuration or overwrite another not saved yet.
- LOAD: to open a configuration file already created and stored.
- SAVE: to save the current configuration in a local file.

Keybox Menu:

- READ: to upload the configuration of the Keybox.
- PROGRAM: to download the current configuration into the Keybox.
- UPDATE FIRMWARE: to update the Keybox firmware where necessary.

Items on the top:

If you click on the tabs at the top (HOME, SYSTEM, etc.) you can access the configuration sheets of the Keybox and the keypads of your system.

- In the main window, you find two additional buttons: ADD KEYPAD to select the keypad model you use to add to your system:



and SYSTEM PARAMETERS to read and set the main working parameters of the system configuration:

System Parameters ✕

Baud Rate [kbps] *

System Configuration Release *

Keybox

CAN Bus Protocol *

Node ID [HEX] *

Keypads Backlight

Color *

ON Brightness [HEX] *

OFF Brightness [HEX] *

Keypads Indicators

Brightness [HEX] *

- At the bottom of the page, during the configuration, a recapitulatory table describes the associated function, the button, the LED and the working parameters for each output pin. The name of the circuit can be assigned to each output pin by filling in the related field.

4. Create a new configuration

1. Click on the icon NEW or Load an existing Configuration file you want to modify (see [Chapter 6](#) for the Load file command).

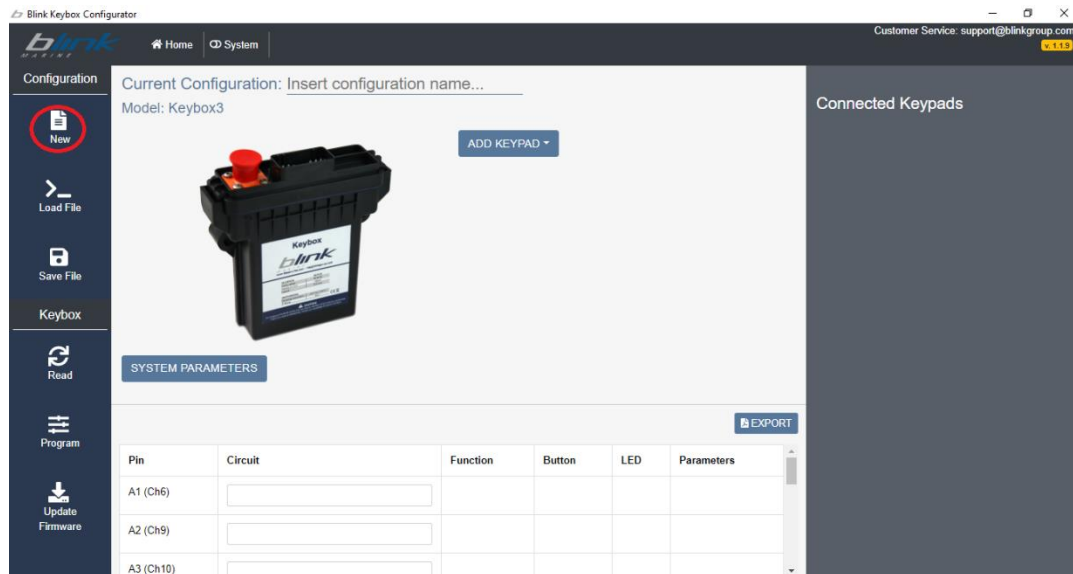

2. Assign a name to the current configuration by filling in the field CURRENT CONFIGURATION:

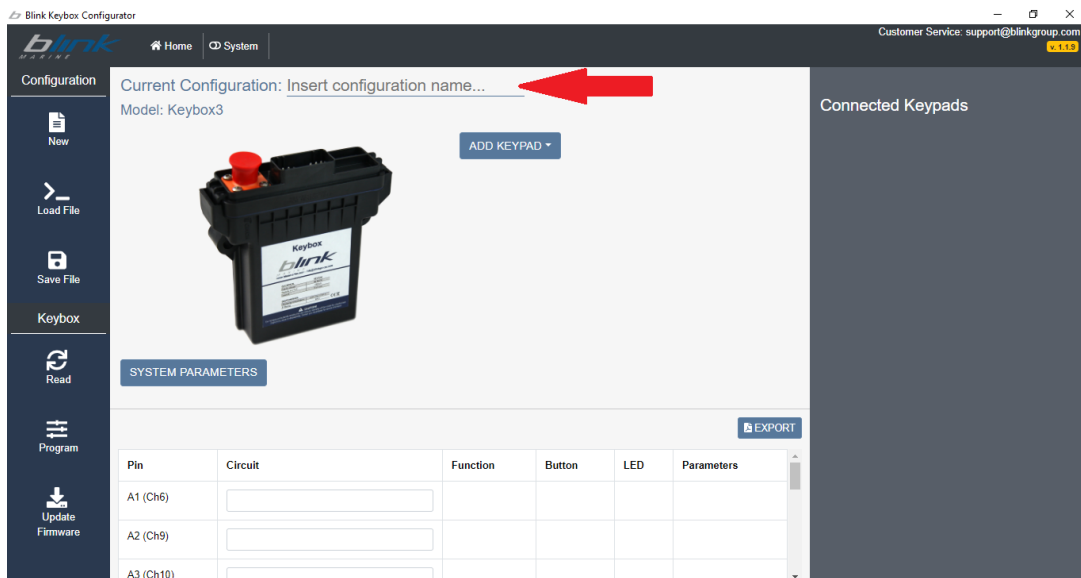

3. Use the button SYSTEM PARAMETERS to set the system parameters as shown in the next pictures:

(a) Set NodeID

The screenshot shows the 'System Parameters' dialog box. The 'Node ID [HEX]' field is highlighted with a blue border and contains the value '1'. A red error message below the field reads: 'The value must be in the range 01h-7Fh excluded 10h-1Fh'. Other fields include Baud Rate (125), System Configuration Release (0), CAN Bus Protocol (CANopen), Keypads Backlight Color (amber), ON Brightness (10), OFF Brightness (0), and Keypads Indicators Brightness (3F).

(b) Set Backlight color

The screenshot shows the 'System Parameters' dialog box with the 'Keypads Backlight Color' dropdown menu open. The menu lists several color options: red, green, blue, yellow, cyan, magenta, white, amber (which is highlighted in blue), and lime. Other fields are the same as in the previous screenshot.

(c) Set Backlight levels

The screenshot shows the 'System Parameters' dialog box with the 'ON Brightness [HEX]' field highlighted in blue and containing the value '20h'. A red error message below the field reads: 'The value must be in the range 00h-20h'. Other fields are the same as in the previous screenshots.

The screenshot shows the 'System Parameters' dialog box with the 'OFF Brightness [HEX]' field highlighted in blue and containing the value '00h'. A red error message below the field reads: 'The value must be in the range 00h-00h'. Other fields are the same as in the previous screenshots.

CAUTION: the values set must be chosen within the range validity.

Note: the parameter *System Configuration Release* can be set with a version number identifying the current configuration.

4. Select the option ADD KEYPAD to choose the keypad model possibly used with the Keybox among the available ones.

5. Assign a name and indicate an address within the range validity to each keypad selected and use the button +CONNECT to connect the keypad to the system. It is possible to add up to 11 keypads, each keypad must have a unique address. By pressing the button "configure" in the *Connected Keypads* menu, the following window will open:

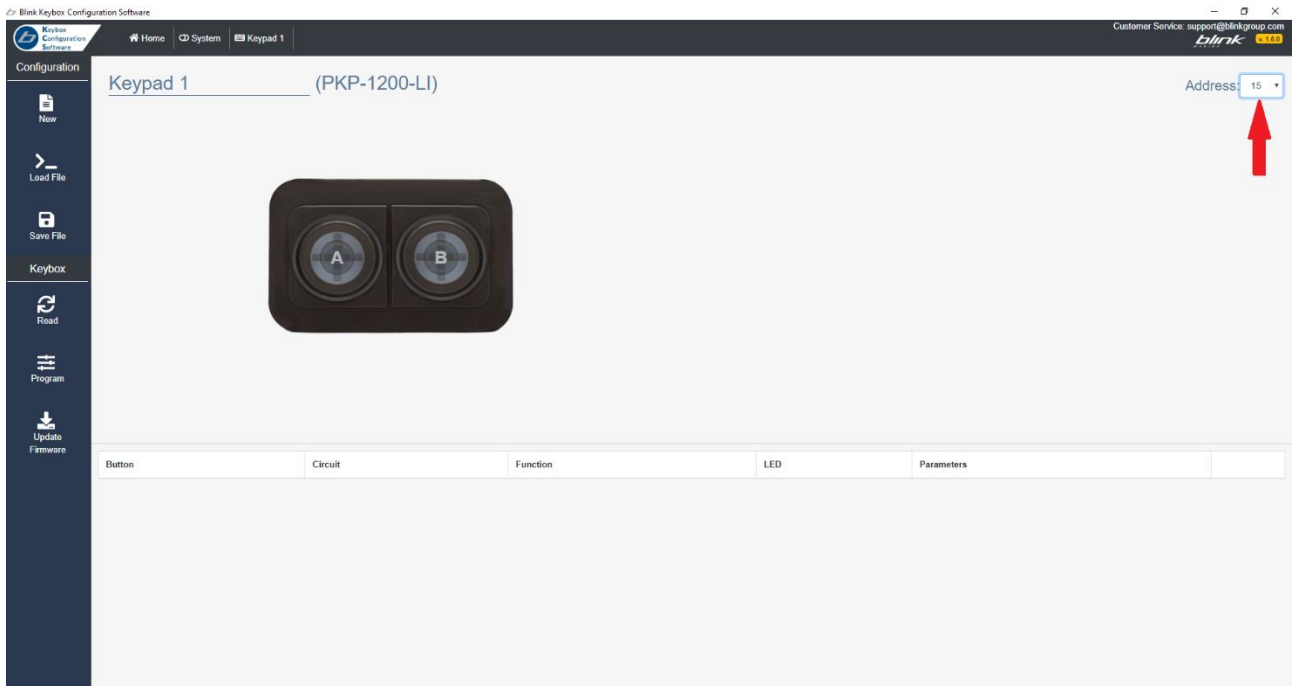

NOTE: as indicated by the red arrow, by selecting the button "address" it is always possible to change the address previously set by choosing one of the available ones:

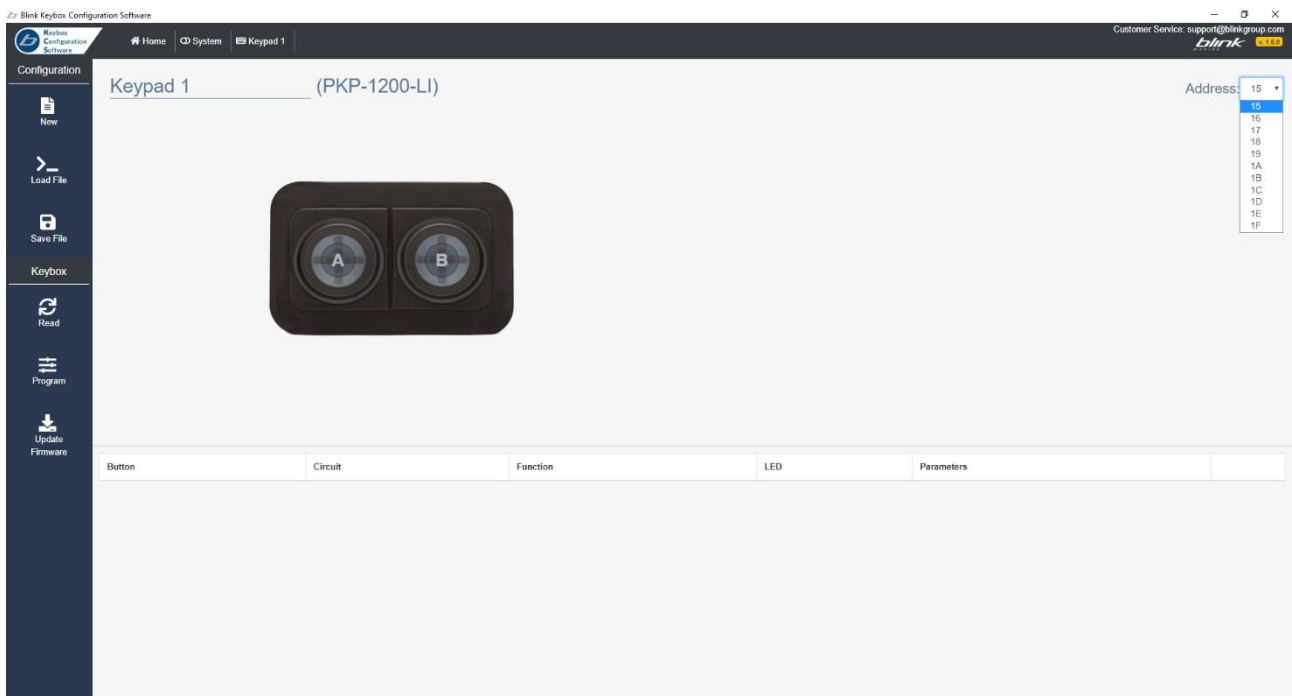

Please refer to the following images for key and LED reference of the keypad models:

PKP2200SI: key/LED number

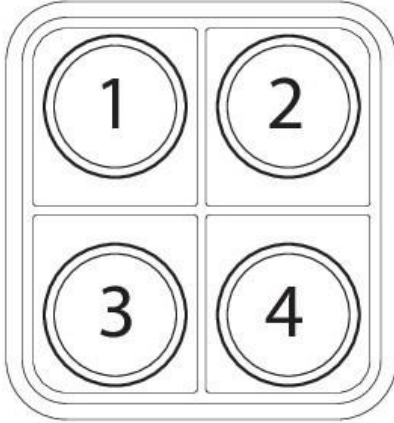

PKP2200LI: key/LED number

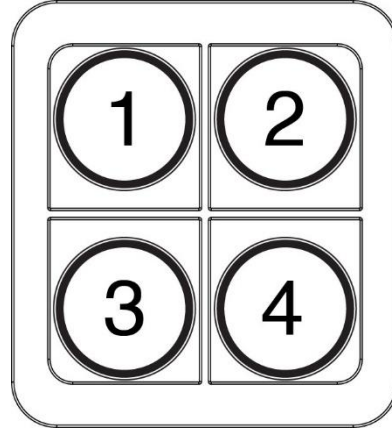

PKP1500LI: key/LED number

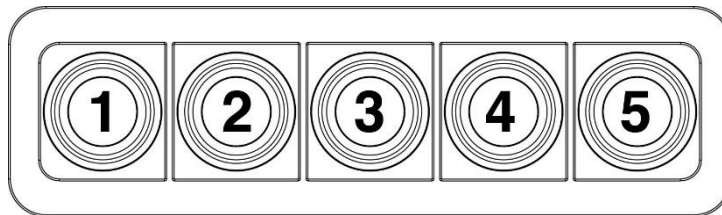

PKP2300SI: key/LED number

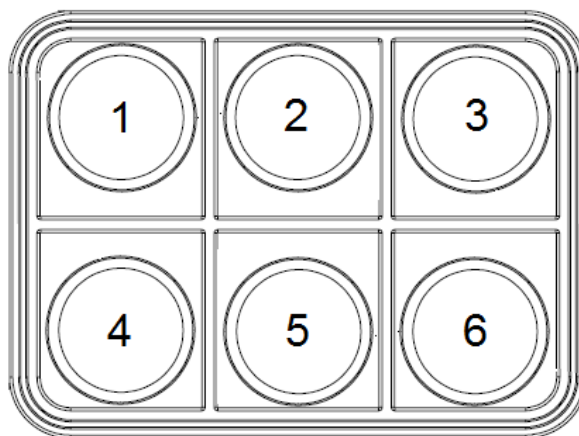

PKP2400SI: key/LED number

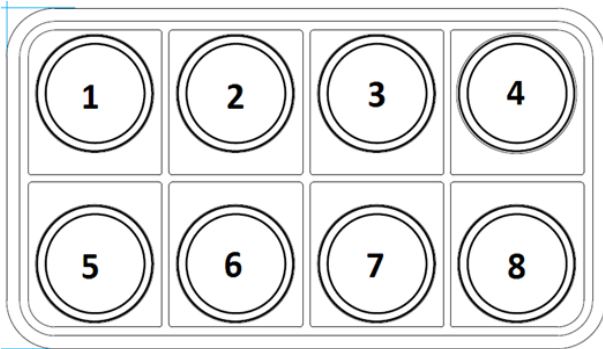

PKP2400LI: key/LED number

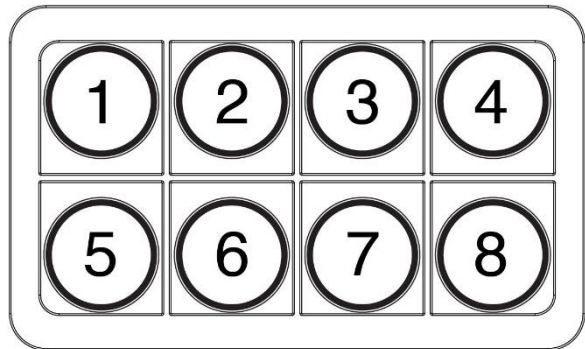

PKP2500SI: key/LED number

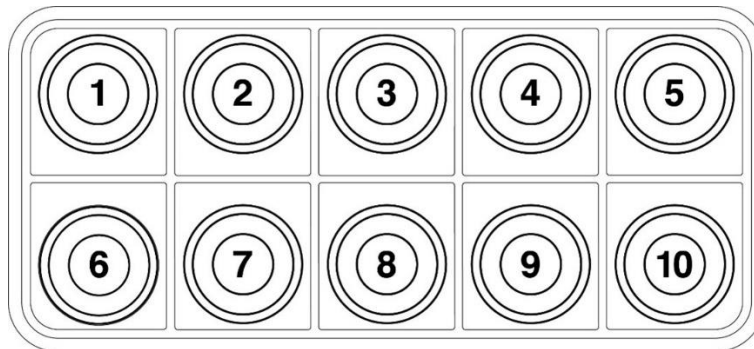

PKP2600SI: key/LED number

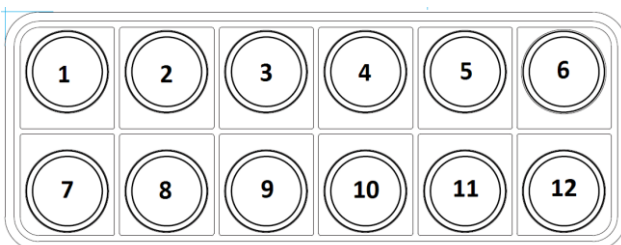

PKP2600-V02: key/LED number

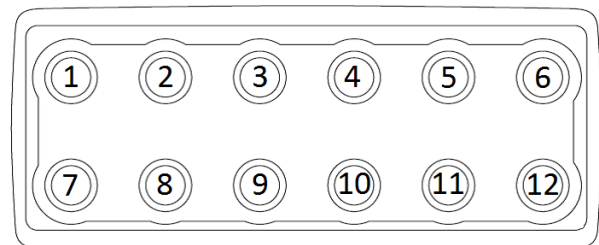

PKP3500SI: key/LED number

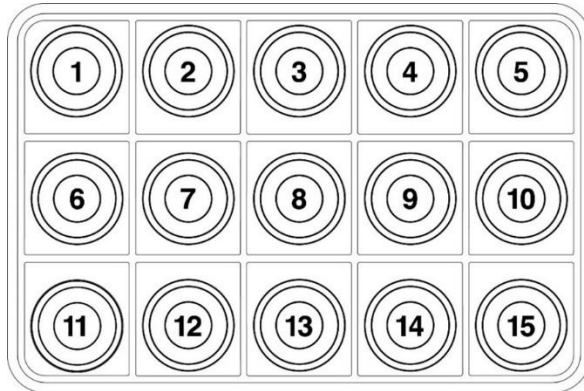

PK1000: LED indicators number

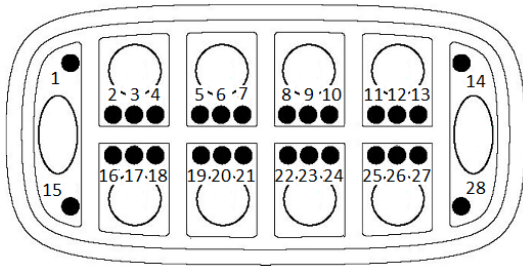

PK1000: key number

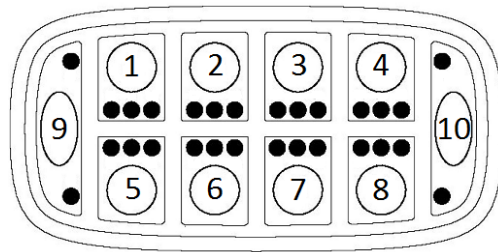

PK1400: LED indicators number

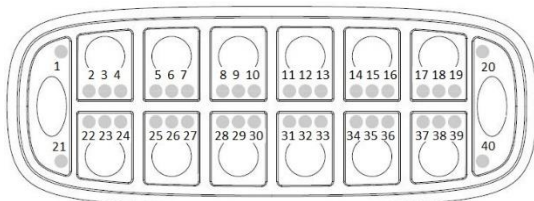

PK1400: key number

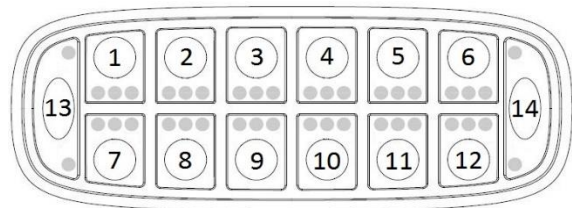

PKP1200LI: key/LED number

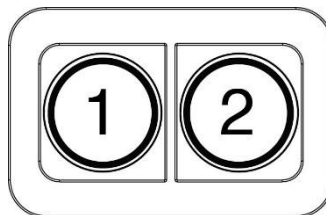

- The keypads connected with their names and addresses are displayed on the right menu as shown in the following illustrative example:

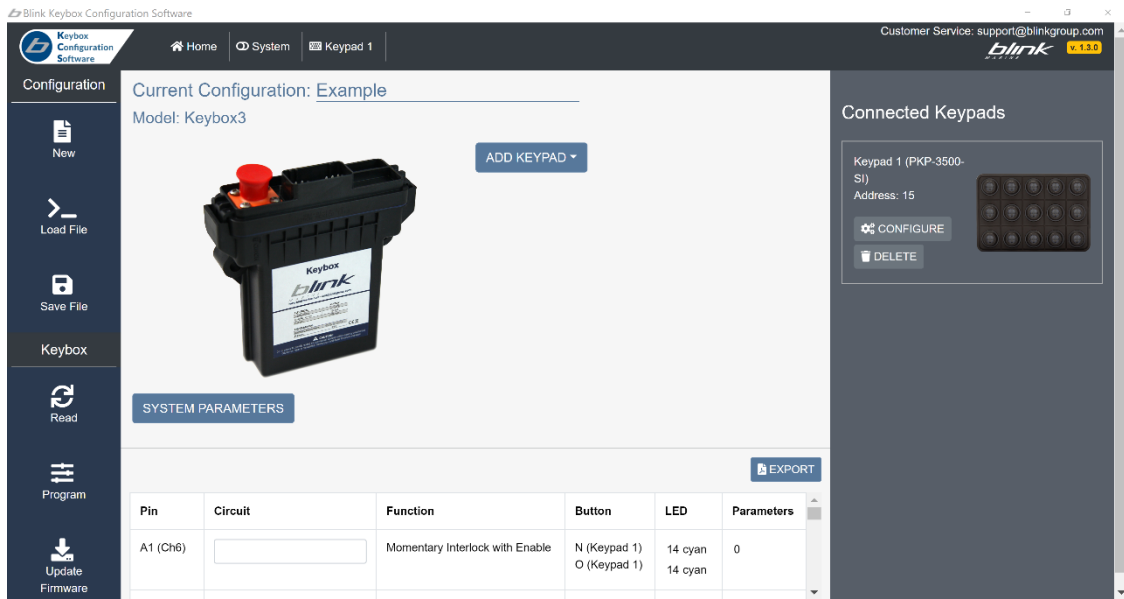

Note: at any time, it is possible to remove a keypad added by clicking on the button DELETE from the related frame.

- If you need to set the system functions associated with no key, from the top menu of the APP click on the tab SYSTEM:

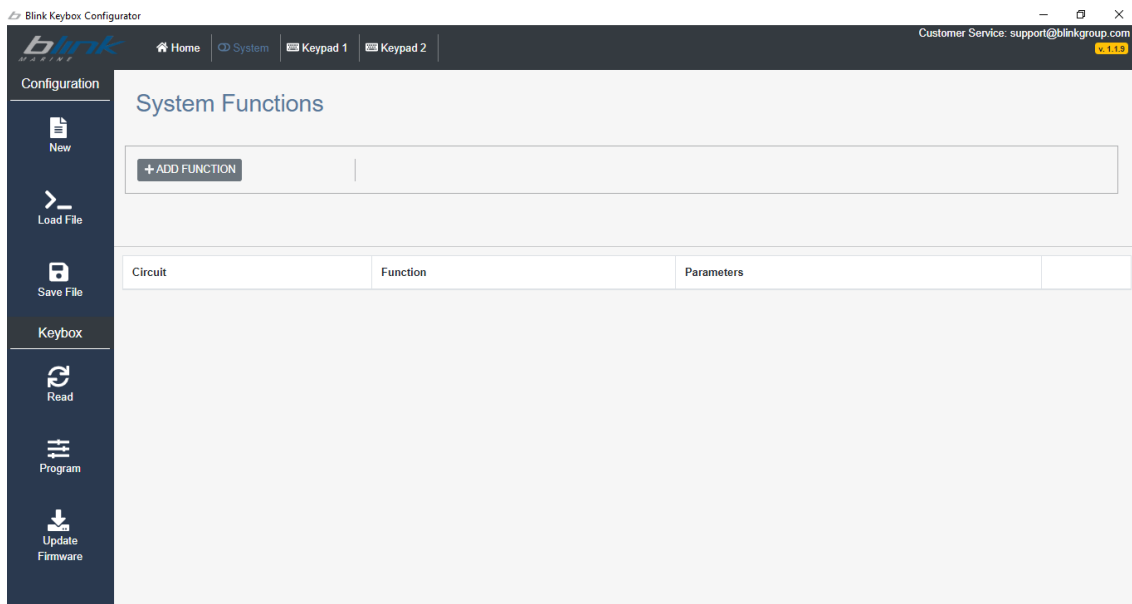

- The button ADD FUNCTION allows the implementation of the desired SYSTEM FUNCTIONS into the system; for some functions, it is necessary to complete one or more mandatory parameters.

CAUTION: if you move to a different tab before saving the function added, a warning will be displayed:

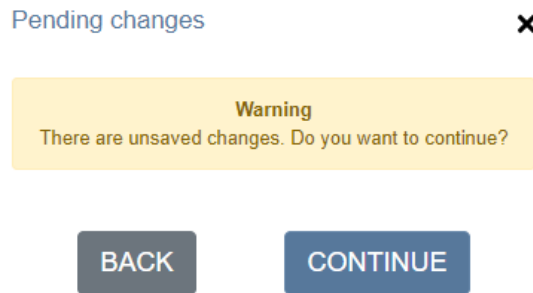

The description of each function is here below:

- BACKLIGHT: the backlight of the keypads goes ON when the selected circuits are at the HIGH logic level. If no circuit is selected, the backlight is always ON. The selected circuits can be dedicated inputs or outputs managed by other functions (e.g., Navigation Lights). To manage the backlight by a keypad button, link the backlight function to the desired button in the keypad configurations section.

WARNING: if an external voltage will be applied to the input pin, remove the related fuse.

Note: the backlight settings (color and brightness level) will be applied according to the parameters used at point 8.

- ALWAYS ON: the circuit is always ON.
- BUS POWER: the circuit shall be used to supply the power to the keypads. It can always be ON or linked to an optional input, enabling the circuit.

WARNING: if an external voltage will be applied to the input pin, remove the related fuse.

CAUTION: if the Keybox powers one or more keypads, an output pin must be dedicated to this function.

- TOGGLE LOW VOLTAGE DETECT: This function detects the low battery voltage condition and manages the related circuits accordingly. The output is turned ON if the battery voltage is below the threshold and OFF if the battery voltage is above the threshold.
- INPUT LEVEL COMMAND: any circuit can be used as a digital input, detecting the power output state or an external voltage. Up to 2 outputs can be linked to that input.

The same pin can work as digital input and power output simultaneously. The digital input can detect the power output state or an external voltage. Do not apply an external voltage to the input pin when the Keybox power is OFF.

WARNING: if the power output is not required, it is recommended to remove the related fuse.

The outputs are turned ON according to the chosen condition:

- ON Condition = 0 : when the input pin is at HIGH logic level.
- ON Condition = 1 : when the input pin is at LOW logic level.
- ON Condition = 2 : on the RISING EDGE of the input pin signal.
- ON Condition = 3 : on the FALLING EDGE of the input pin signal.
- ON Condition = 4 : DISABLED.

The outputs are turned OFF according to the chosen condition:

- OFF Condition = 0 : when the input pin is at LOW logic level.
- OFF Condition = 1 : when the input pin is at HIGH logic level.
- OFF Condition = 2 : on the RISING EDGE of the input pin signal.
- OFF Condition = 3 : on the FALLING EDGE of the input pin signal.
- OFF Condition = 4 : DISABLED.

CAUTION: some functions require to be implemented on specific circuits only!

CAUTION: the maximum current supported for each output pin is specified in the table of [chapter 11](#)

- To save the function and the related parameters set, click on SAVE.

Note: the configuration of the functions is summarized with the data set in the table bottom in the SYSTEM FUNCTIONS sheet.

- To configure the functions associated with the keys of the keypads, click on the button CONFIGURE of the related keypad on the home screen or move to the appropriate tab by selecting the name of the keypad in the top menu.
- To set one of the available functions and associate it to a specific key, it is necessary to click on the desired key, which will be highlighted in yellow, and select the function as shown in the following screenshot:

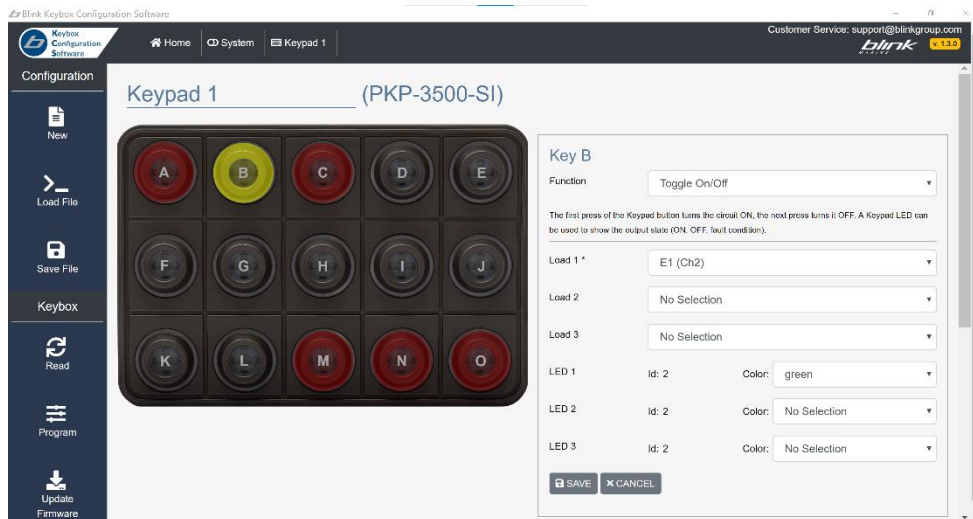

The description of the functions is here below:

- MOMENTARY:** the circuit is ON while the keypad button is held down. A keypad LED can be used to show the output state (ON, OFF, fault condition).
- TOGGLE ON/OFF:** the first press of the keypad button turns the circuit ON, the next press turns it OFF. A keypad LED can be used to show the output state (ON, OFF, fault condition).
- SEQUENCE 1-1-2-0:** the first press of the keypad button turns the first circuit ON. The second press of the keypad button turns the second circuit ON and the first circuit OFF. The third press turns both circuits ON, and the fourth press turns both circuits OFF. One keypad LED for each circuit can be used to show the output state (ON, OFF, fault condition).
- SEQUENCE 1-2-0:** the first press of the keypad button turns the first circuit ON. The second press of the keypad button turns both circuits ON. The third press turns both circuits OFF. One keypad LED for each circuit can be used to show the output state (ON, OFF, fault condition).
- SEQUENCE 1-1-0:** the first press of the keypad button turns the first circuit ON. The second press of the keypad button turns the second circuit ON and the first circuit OFF. The third press also turns the second circuit OFF. One keypad LED for each circuit can be used to show the output state (ON, OFF, fault condition).
- SEQUENCE 2-1-0:** The first press of the Keypad button turns both circuits ON. The second press of the Keypad button turns the second circuit OFF. The third press also turns the first circuit OFF. One keypad LED for each circuit can be used to show the output state (ON, OFF, fault condition).
- SEQUENCE 1-1-1-0:** The first press of the Keypad button turns the first circuit ON. The second press of the Keypad button turns the second circuit ON and the first circuit OFF. The third press of the Keypad button turns the third circuit ON and the second circuit OFF. The fourth press turns all circuits OFF. One keypad LED for each circuit can be used to show the output state (ON, OFF, fault condition).
- COUNTDOWN:** the first press of the keypad button turns the circuit ON. The next press turns the circuit OFF. When the circuit goes ON, a countdown starts, it will switch the circuit OFF automatically upon "Setting Time" expiration. A keypad LED can be used to show the output state (ON, OFF, fault condition).

- **BILGE PUMP:** the first press of the keypad button turns the circuit ON in MANUAL mode. The second press turns the circuit OFF. When the circuit goes ON, a countdown starts, it will switch the circuit OFF automatically upon “Setting Time” expiration (select 0 to disable the countdown). When the circuit is OFF, the contact pin will sense when the pump is being turned ON by the float switch (AUTO mode). The float switch shall be wired directly to the battery via a fused wire, as shown in figure 1. The keypad LEDs can be used to show the output state (ON, OFF, AUTO, fault condition).

Figure 1

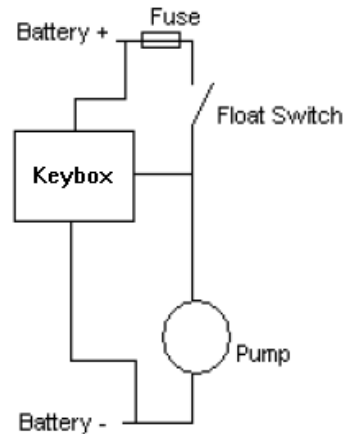

- **BACKLIGHT:** the first press of the keypad turns the backlight of the keypads ON, the next press turns it OFF. To manage the backlight by a Keybox input/output circuit, link the backlight function to the desired circuit in the Keybox configuration section.
- **ALWAYS ON:** the circuit is always ON. An optional keypad LED can be used to show the output state (ON, OFF, fault condition), the keypad button can be used to reset the fault condition.
- **TOGGLE LOW VOLTAGE DETECT:** This function detects the low battery voltage condition and manages the related circuits accordingly. The first press of the Keypad button turns the circuit ON, the next press turns it OFF, if the battery voltage drops below the threshold, the output is turned OFF and disabled. A Keypad LED can be used to show the output state (ON, OFF, fault condition, disabled).
- **DIMMER:** a fast press of the keypad button turns the circuit ON and OFF as a toggle function. Holding the keypad button for more than 1 second makes the output voltage gradually decrease, starting from the maximum value. Releasing and pressing the button again makes the output voltage gradually increase to the maximum value. A keypad LED can be used to show the output state (ON, OFF, fault condition).
- **TOGGLE-NORMAL ON:** at startup, the circuit is ON. The keypad button can switch the circuit OFF and ON as a standard toggle function. A keypad LED can be used to show the output state (ON, OFF, fault condition).

- INPUT LEVEL COMMAND: any circuit can be used as a digital input, detecting the power output state or an external voltage. Up to 2 outputs can be linked to that input. The same pin can work as digital input and power output simultaneously. The digital input can detect the power output state or an external voltage. Do not apply an external voltage to the input pin when the Keybox power is OFF.

WARNING: if the power output is not required, it is recommended to remove the related fuse.

The outputs are turned ON according to the chosen condition:

- ON Condition = 0 : when the input pin is at HIGH logic level.
- ON Condition = 1 : when the input pin is at LOW logic level.
- ON Condition = 2 : on the RISING EDGE of the input pin signal.
- ON Condition = 3 : on the FALLING EDGE of the input pin signal.
- ON Condition = 4 : DISABLED.

The outputs are turned OFF according to the chosen condition:

- OFF Condition = 0 : when the input pin is at LOW logic level.
- OFF Condition = 1 : when the input pin is at HIGH logic level.
- OFF Condition = 2 : on the RISING EDGE of the input pin signal.
- OFF Condition = 3 : on the FALLING EDGE of the input pin signal.
- OFF Condition = 4 : DISABLED.

A keypad LED can be used to show the output state (ON, OFF, fault condition) or, the input level (LOW or HIGH).

- MOMENTARY INTERLOCK WITH ENABLE: this function requires two keypad buttons and two circuits. Each circuit is ON while the relative button is held down, when one of the outputs is ON, the second output cannot be operated (two circuits are interlocked). If the "enable time" has been set different from 0, the circuits are normally disabled. The first press of one of the two keypad buttons enables the circuits for the defined time. The keypad buttons can operate the relative outputs when the circuits have been enabled. The countdown, that will disable the circuits once expired, is refreshed every time a button is pressed. The first keypad LED can be used to show the output state (ON, OFF, fault condition). The second keypad LED can be used to show the "enabled" or "disabled" state.

CAUTION: some functions require to be implemented on specific circuits only!

CAUTION: the maximum current supported for each output pin is specified in the table of [chapter 11](#).

Notes:

- For each function, some parameters are mandatory (marked by *).
- For each load used it is possible to associate to the LED indicator (Id) of the selected key a specific color, which will be switched solid on or blinking to represent the output state: active or fault. The LED is OFF when the circuit is not active.
- For PKP series keypads the colors generally available are green, red, blue, amber, cyan, violet, and white, except for SEQUENCE functions where it is possible to select only the primary colors (RED, GREEN, BLUE).
- For PK series keypads the only colors available are red and green.

12. To complete the configuration of the key, click on SAVE.

CAUTION: if you move to a different tab before saving the function added, a warning will be displayed:

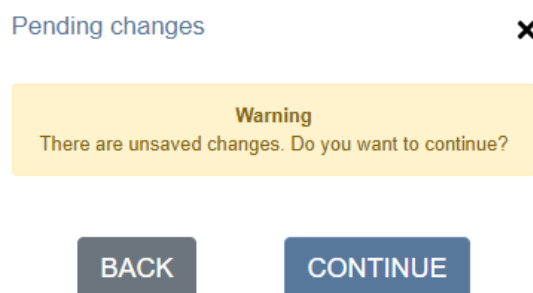

The configured key is highlighted in red, and the configuration saved associated with the key is added to the table as shown in the following example:

Blink Keybox Configurator

Home System Keypad 1 Keypad 2

Customer Service: support@blinkgroup.com

Configuration

Keypad 1 (PKP-1500-LI)



Button	Circuit	Function	LED	Parameters	
A	A1 (Ch6)	Toggle On/Off	1 green		

Configuration sidebar:

- New
- Load File
- Save File
- Keybox
- Read
- Program
- Update Firmware

5. Save a configuration

1. Once completed the configuration of the functions of the system and the keypads, it is possible to check it by looking at the table on the bottom of the home page. If there is no need to modify it, you can save it in a file by clicking on the button SAVE as shown here below:

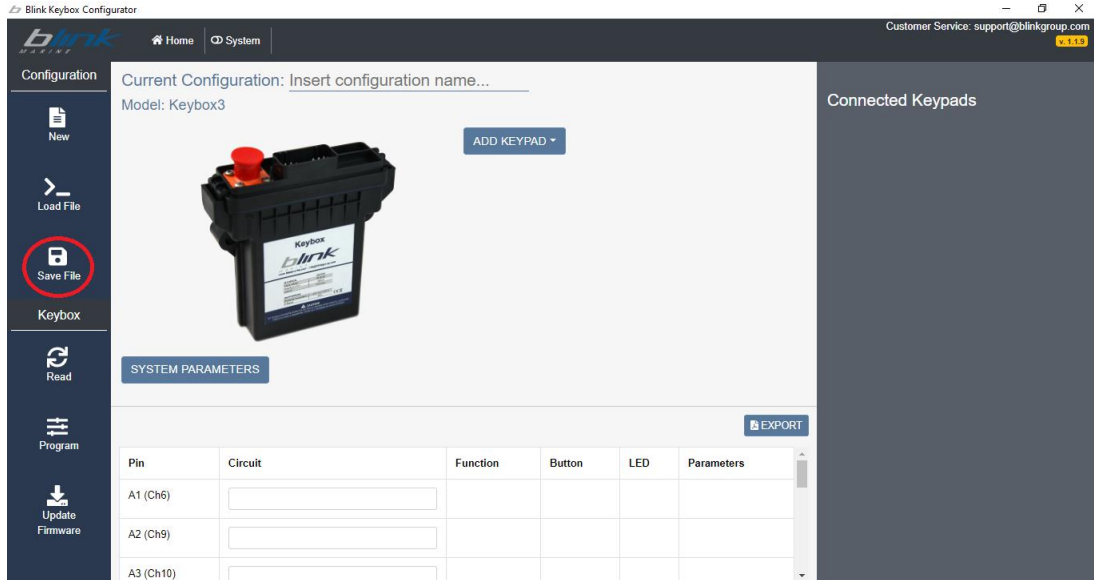

The saved file can be shared between users and stored for future modifications or backup purposes.

It is also possible to export in PDF format the configuration table by using the button EXPORT placed above the table. The table summarizes the entire configuration of the system.

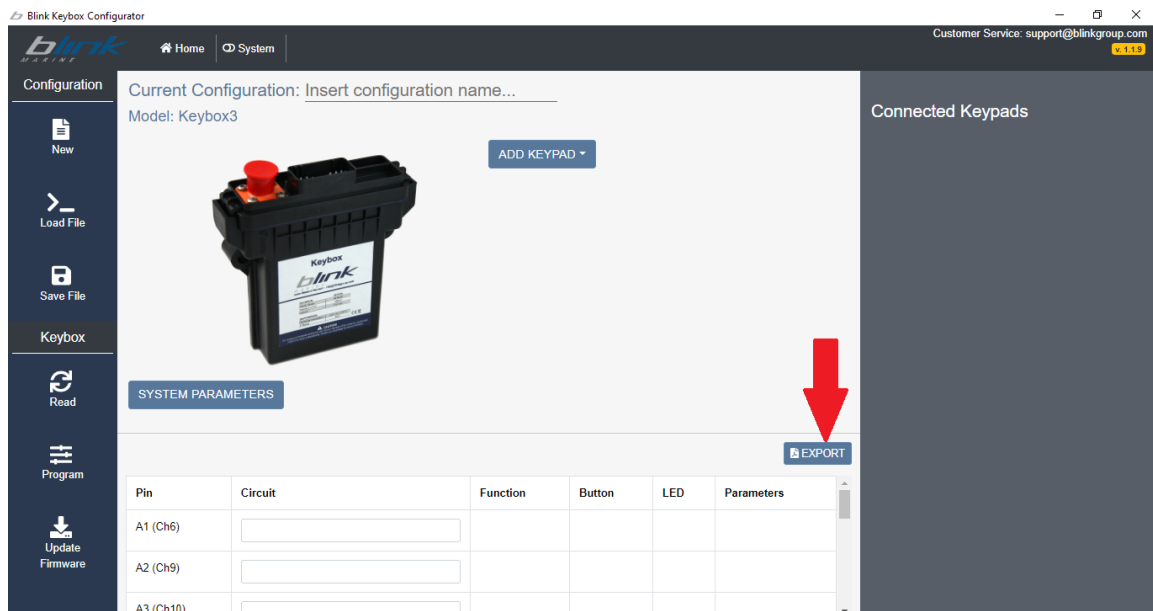

6. Load a configuration

If a configuration has been already created and it is desired to open it, the function to be used is LOAD. By clicking on this button, the program requires the path of the related configuration file (*.json) on your PC and, once selected, the configuration will be loaded as shown in the next pictures:

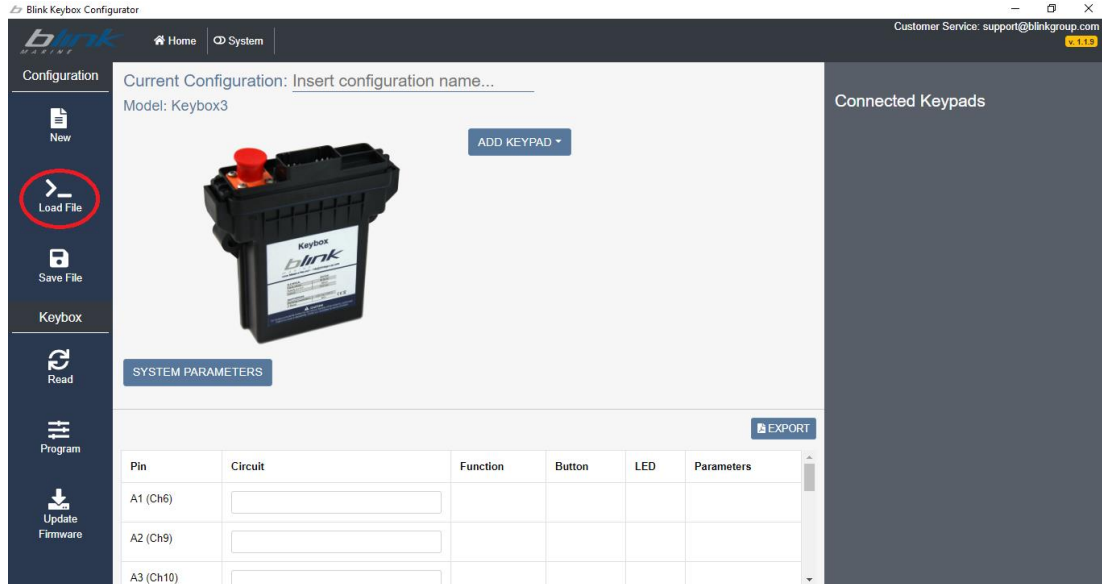

Configuration "Example" loaded:

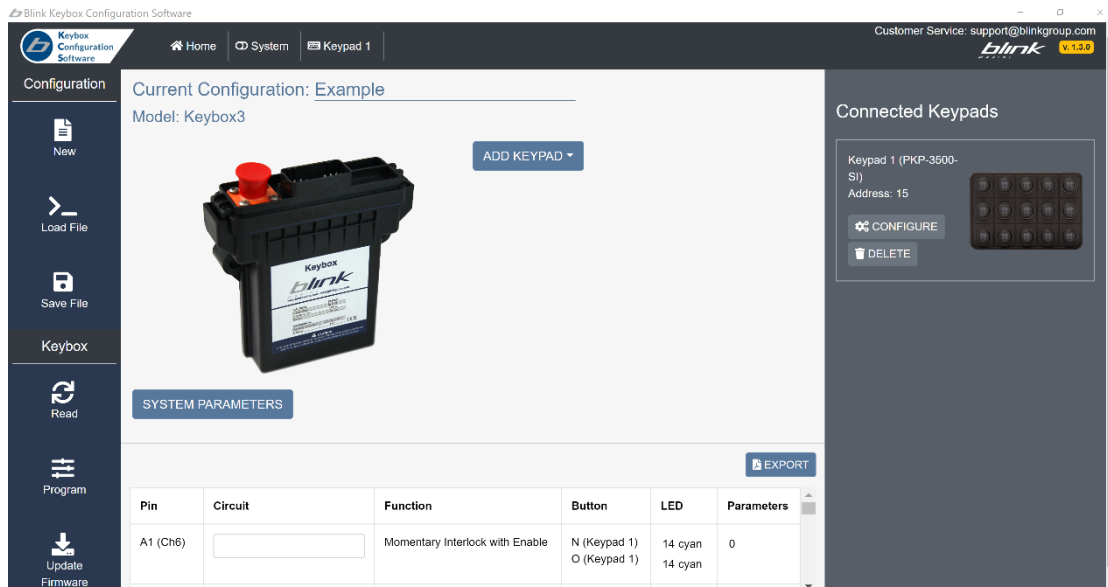

7. Read a configuration from the Keybox

The Blink Keybox Configurator program has a feature that allows you to upload the configuration present in your Keybox.

1. After connecting the Keybox to PC with an RS485/CAN³-USB interface as shown in [chapter 10](#) or with the RS485-USB adapter provided by Blink as described in the [appendix](#), click on the button READ:

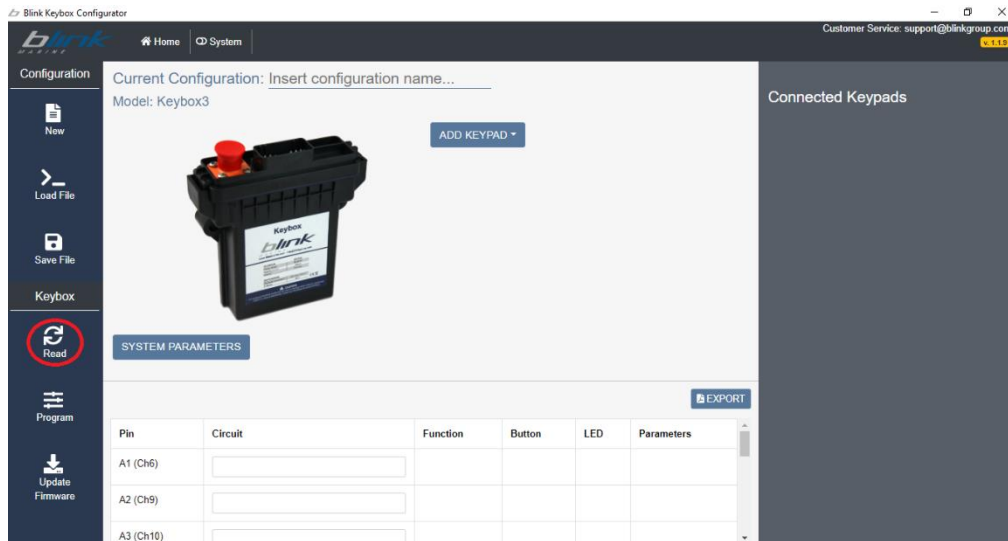

A window invites to select the fields "Connection Device" and "Baudrate" in compliance with the connected USB interface and the current baud rate and warns the Keybox is the only communication device connected.

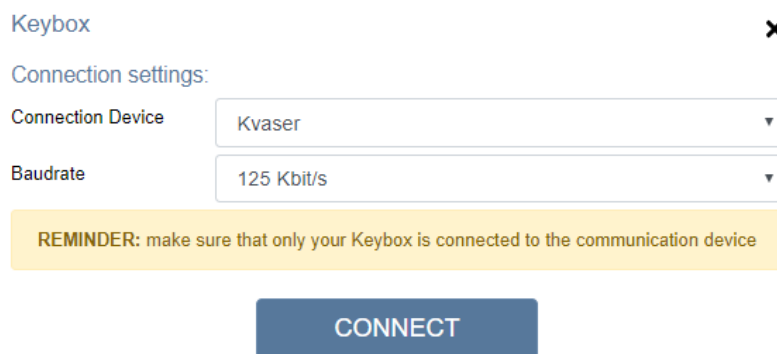

³The supported CAN bus interfaces are KVASER or PEAK SYSTEM branded. Some interfaces require an external 120 Ω terminating resistor between CAN-H and CAN-L lines: in this case place it, if not present inside the Keybox.

2. Once checked these settings, click on the button CONNECT. After a few instants, an on-screen message summarizing the Keybox data invites to click on READ to start the procedure:

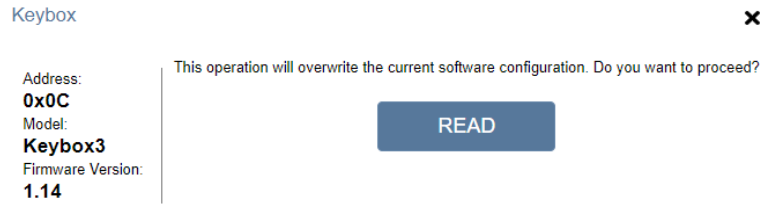

3. While the process is running, a progress bar indicates the time remaining.

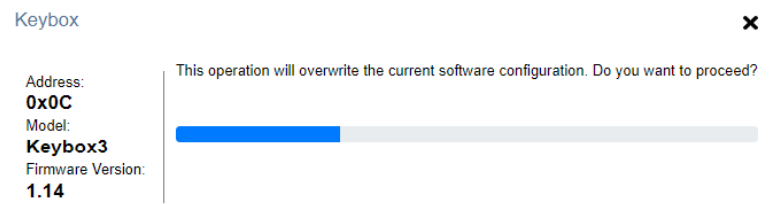

4. If the procedure is successful, the following window will be displayed:

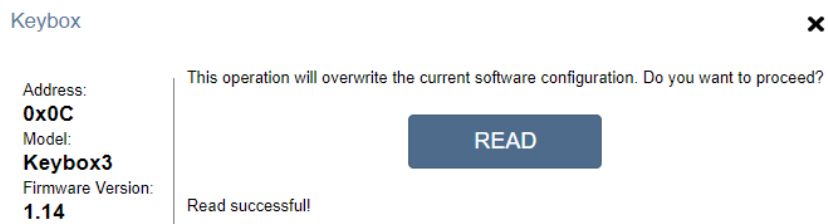

On the table present on the home screen, it is now possible to read the configuration.

8. Program the Keybox with a new configuration

It is possible to download into your Keybox a new configuration or one already created loaded into the configurator, by pressing the button PROGRAM.

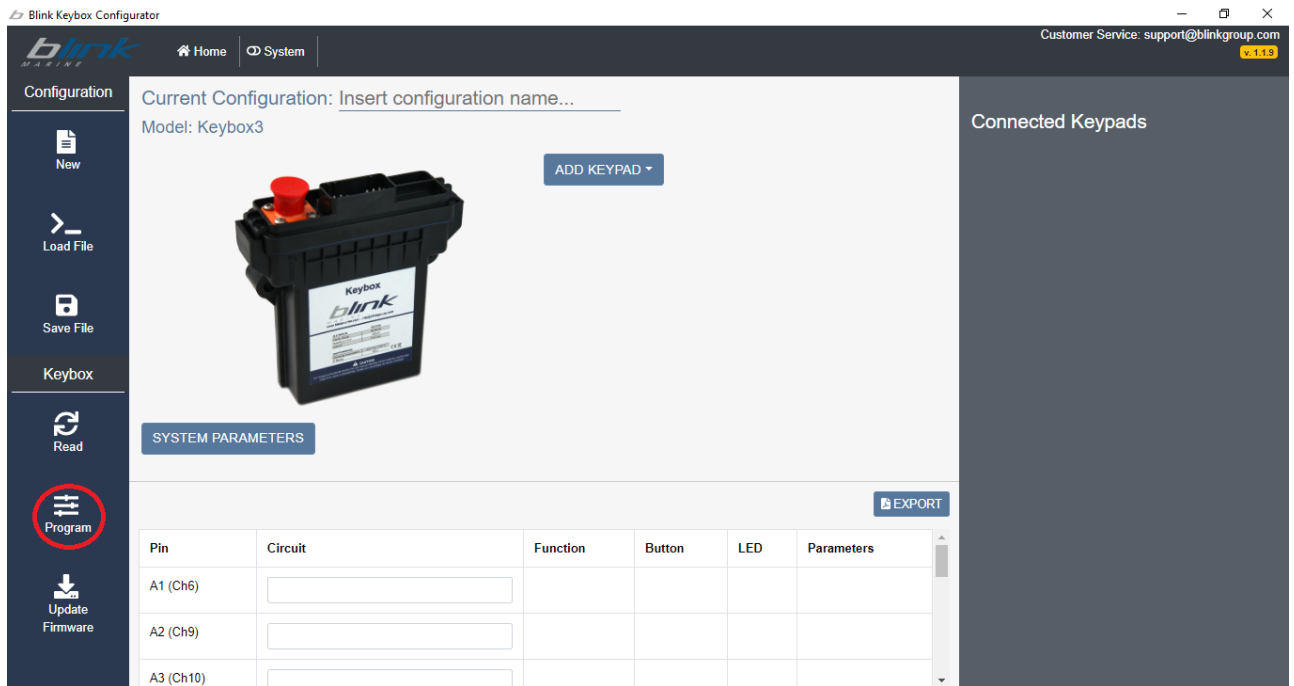

1. Connect the Keybox to PC with an RS485/CAN⁴-USB interface as shown in [chapter 10](#) or with the RS485-USB adapter provided by Blink as described in the [appendix](#) and make sure the Keybox is the only communication device connected.

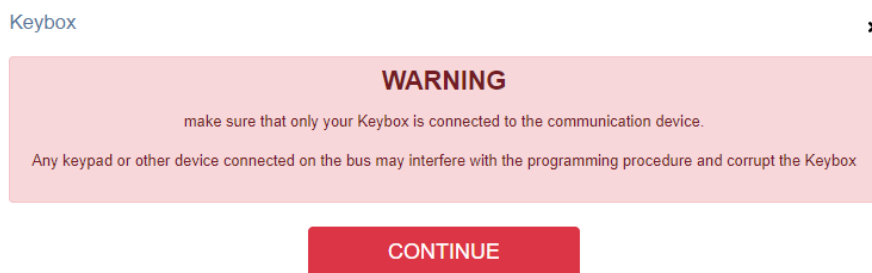

⁴ The supported CAN bus interfaces are KVASER or PEAK SYSTEM branded. Some interfaces require an external 120 Ω terminating resistor between CAN-H and CAN-L lines: in this case place it, if not present inside the Keybox.

- After that, click on CONTINUE and fill in the fields of the new window in compliance with the interface used, as shown in the following example:

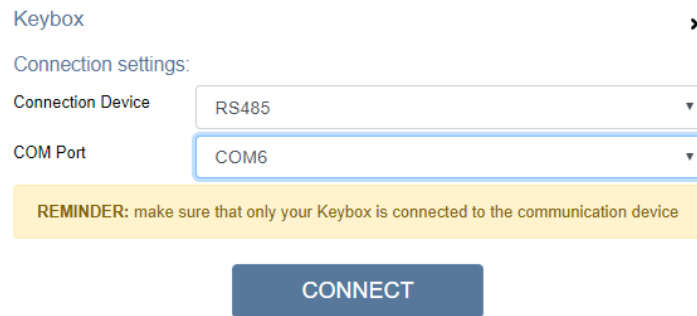

- Press CONNECT and wait for the message that confirms your Keybox is connected correctly and ready to be programmed.

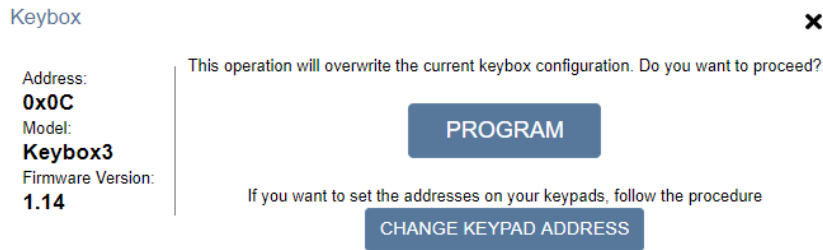

Note: if the connection fails, check the diagram connection to [chapter 10](#).

- When the message above is displayed, click on PROGRAM to start the procedure, or skip to point number 7 if it is just needed to set the addresses on the keypads.
- While the process is running, a progress bar indicates the time remaining.

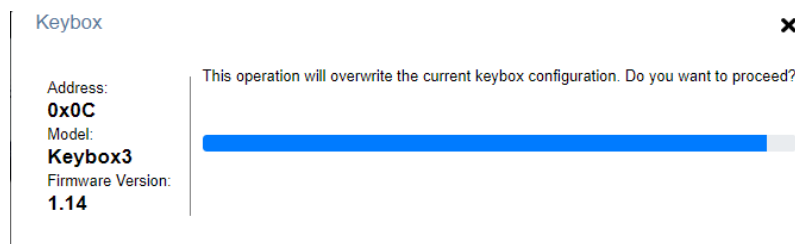

CAUTION: do not disconnect the cables and do not close the application until the end of the download.

- When the process is complete, the following window will be displayed:

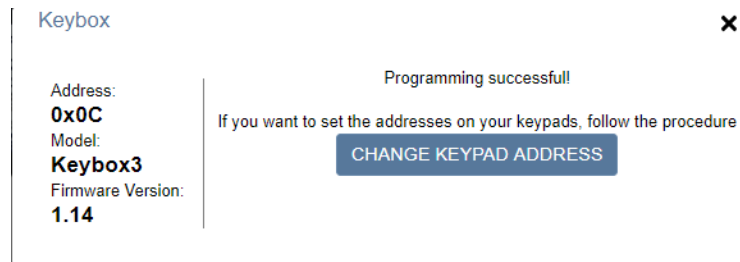

7. Regardless of whether the Keybox has been programmed or not, it is possible to set the addresses of the keypads which will be used with the Keybox. This feature is available by clicking the button CHANGE KEYPAD ADDRESS.

The program shows the keypad model to be connected to the Keybox.

Note: check the keypad connection in the diagram connection to [chapter 10](#).

Note: this step can be skipped if the keypad addresses are already configured.

CAUTION: Connect one keypad at a time and anyway only the one shown in the window making sure the other ones are disconnected!

CAUTION: the keypads must work with CANopen communication protocol and SW2.13 or later.

8. Click START and press any button on the keypad. Some buttons will light up to indicate the process has been run correctly; click DONE to set the address of the other keypads or complete the procedure.

9. Update firmware

This feature makes it possible to update the Keybox to the latest firmware version available (v.1.14) or download the programming files related to a previous or custom firmware.

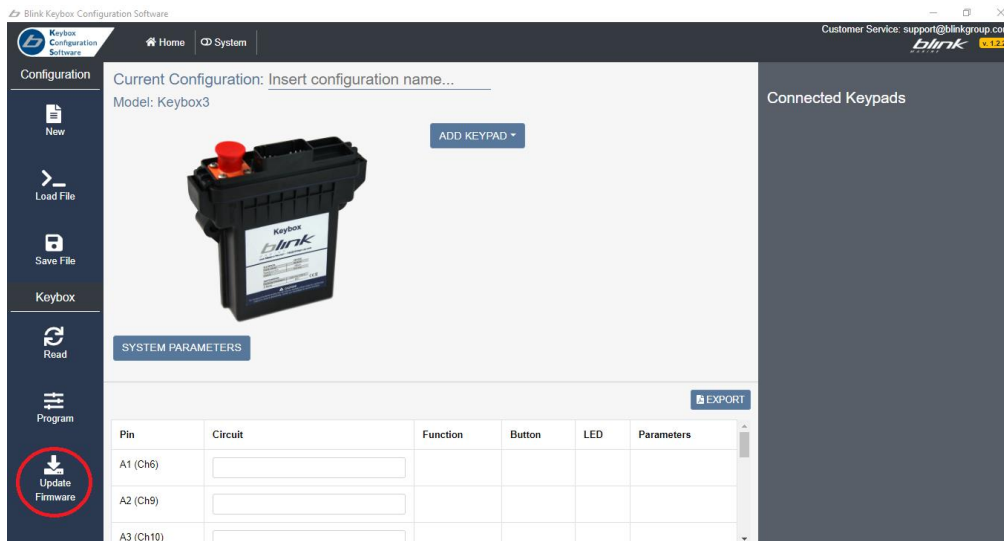

CAUTION: the current configuration of the Keybox will be deleted. It is recommended to read the configuration from Keybox, save it in a local directory and once the firmware is updated, restore the Keybox programming in the saved configuration.

CAUTION: use the programming files released by Blink only!

Warning: do not disconnect the Keybox during the update procedure!

1. Connect the Keybox to PC with an RS485/CAN⁵-USB interface as shown in [chapter 10](#) or with the RS485-USB adapter provided by Blink as described in the [appendix](#) and make sure the Keybox is the only communication device connected.
2. Once pressed the button circled in red, a warning window remembers the Keybox must be the only communication device connected.

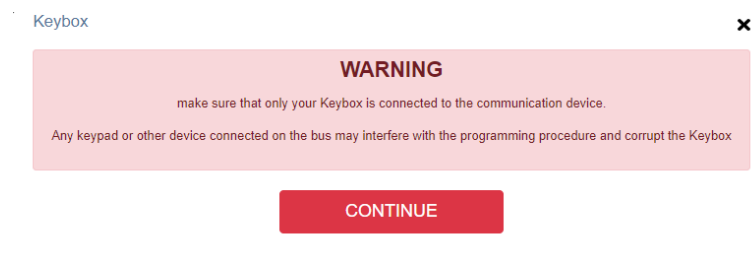

⁵ The supported CAN bus interfaces are KVASER or PEAK SYSTEM branded. Some interfaces require an external 120 Ω terminating resistor between CAN-H and CAN-L lines: in this case place it, if not present inside the Keybox.

- 3. Click on CONTINUE and fill in the fields of the *Connection settings* windows in compliance with the interface used and the current baud rate of your Keybox:

- 4. Press CONNECT.

If it is desired to update your device to the latest firmware version:

- In the next window click on *Update to version 1.14* and press the button UPDATE to start the procedure as shown here below:

- While the process is running, a progress bar indicates the time remaining:

- The procedure is successfully complete when the following message is displayed:

Keybox



Address:
0x0C
Model:
Keybox3
Firmware Version:
1.14

- Update to version 1.14
- Select firmware files

Hex File SELECT

Eep File SELECT

This operation will overwrite the current keybox firmware. Do you want to proceed?

Programming successful! Restart your keybox to test.

If, on the contrary, it is desired to download into the device a previous or a custom version:

- In the next window, click on *Select firmware files* and select the congruent programming files (.hex/.eep) from the proper directory of your PC.

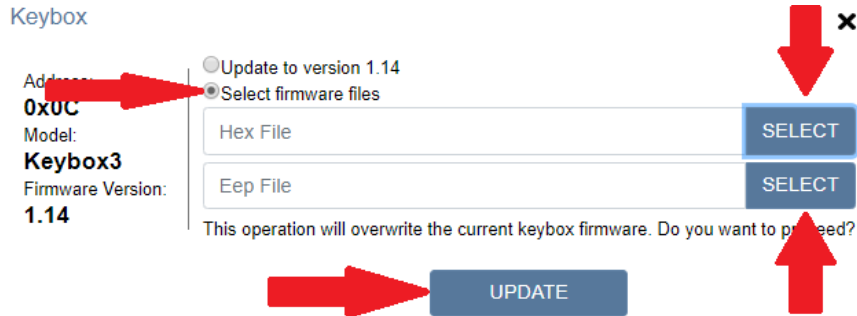

- Once selected the files, click the button UPDATE to start the procedure.

CAUTION: do not disconnect the cables and do not close the application until the end of the download.

- While the process is running, a progress bar indicates the time remaining:

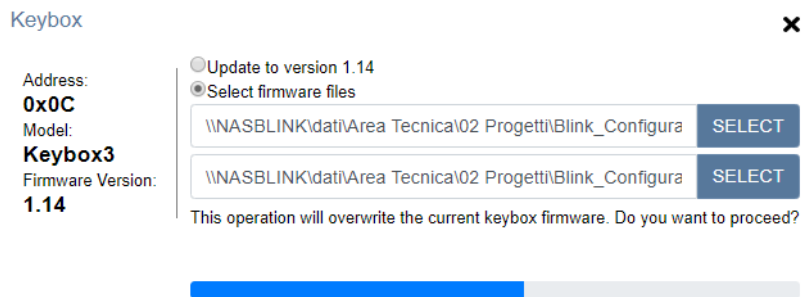

- After a few instants if the procedure is successful, the following message will be displayed:

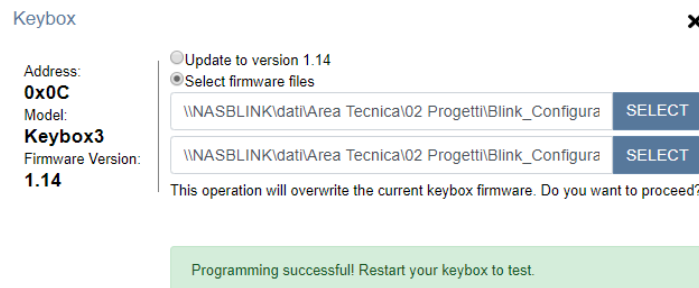

5. Once restarted, the Keybox is equipped with the selected firmware.

Warning: if during the update any problem or an undesired disconnection of the device from the wiring occurs, the procedure will not be completed, and the following message will be displayed:

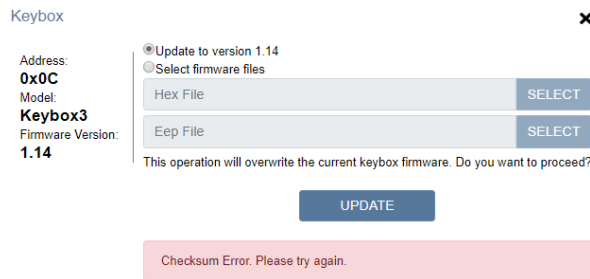

In this case:

- close the current window and click again UPDATE FIRMWARE. By pressing the button CONNECT, after some instants the following window will be displayed

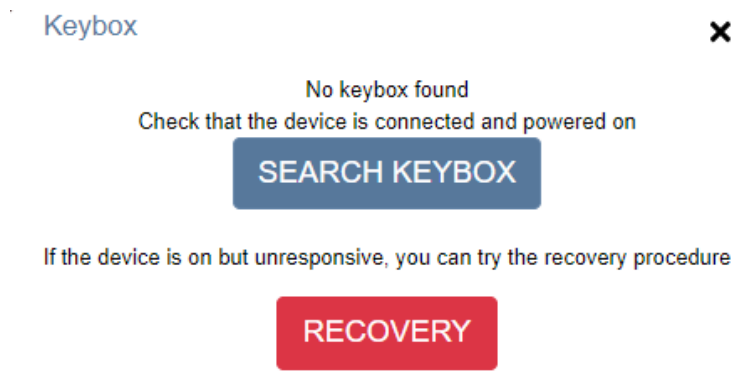

- Click on the button RECOVERY and follow the instructions listed in the WARNING window:

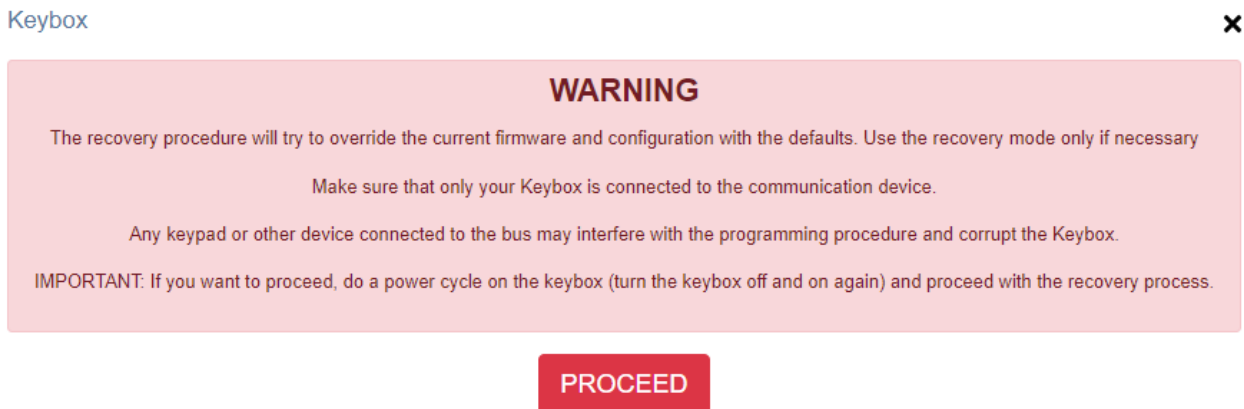

- Click on the button PROCEED, and in the following window press the button RECOVERY:

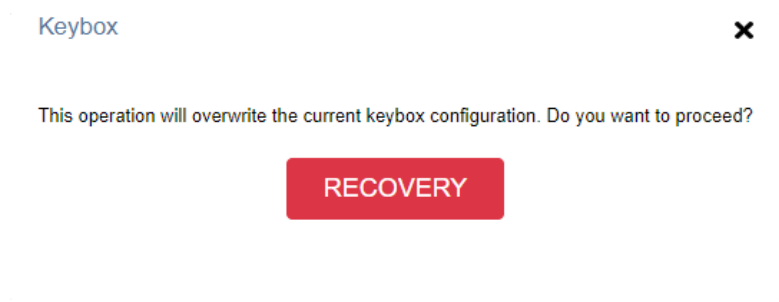

- Wait for the Keybox to be recovered:

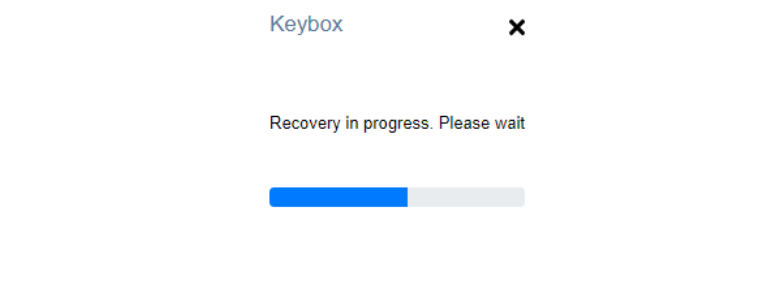

If the process is successfully complete, the following message will be displayed:

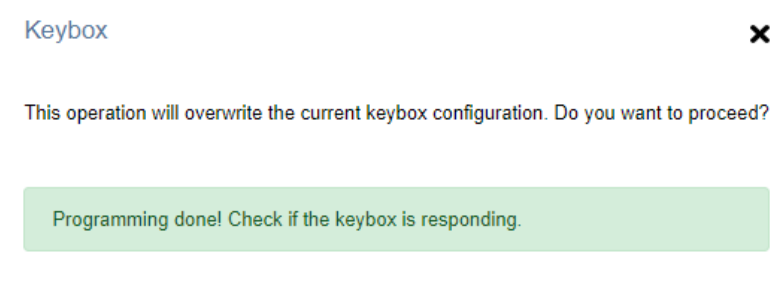

- Close the current window and press the button UPDATE FIRMWARE to check the Keybox to respond correctly.
- If, after pressing the button CONNECT, the window below is shown, the Keybox is updated and ready for use:

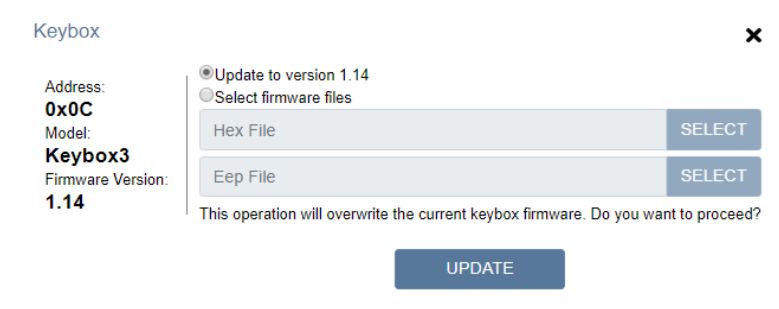

10. Electrical connections

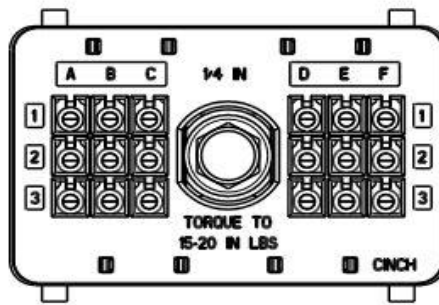

18pin Cinch harness connector 5810118038 mating with Cinch harness connector 5810118023

The following table specifies the maximum current for each output pin of the Keybox depending on the version used:

Pin	Output	Maximum current		
		Version 12V-5A	Version 12V-10A	Version 24V-5A
A1	Ch6	5A	10A	5A
A2	Ch9	5A	10A	5A
A3	Ch10	5A	10A	5A
B1	Ch5	5A	10A	5A
B2	BUS	-	-	-
B3	Ch1	5A	10A	5A
C1	Ch4	5A	10A	5A
C2	Ch12	3A	3A	3A
C3	BUS	-	-	-
D1	Ch13	3A	3A	3A
D2	BUS	-	-	-
D3	Power	-	-	-
E1	Ch2	5A	10A	5A
E2	BUS	-	-	-
E3	Ch7	5A	10A	5A
F1	Ch3	5A	10A	5A
F2	Ch11	5A	10A	5A
F3	Ch8	5A		5A

Keypad connector pinout:

PIN	COLOUR	FUNCTION
1	Blue	CAN L
2	White	CAN H
3	Black	Negative battery
4	Red	Vbatt. (12-24V)



Keypad connector AMPHENOL AT04-4P

11. Connection Diagram

USB to CAN bus interface

Figure 1

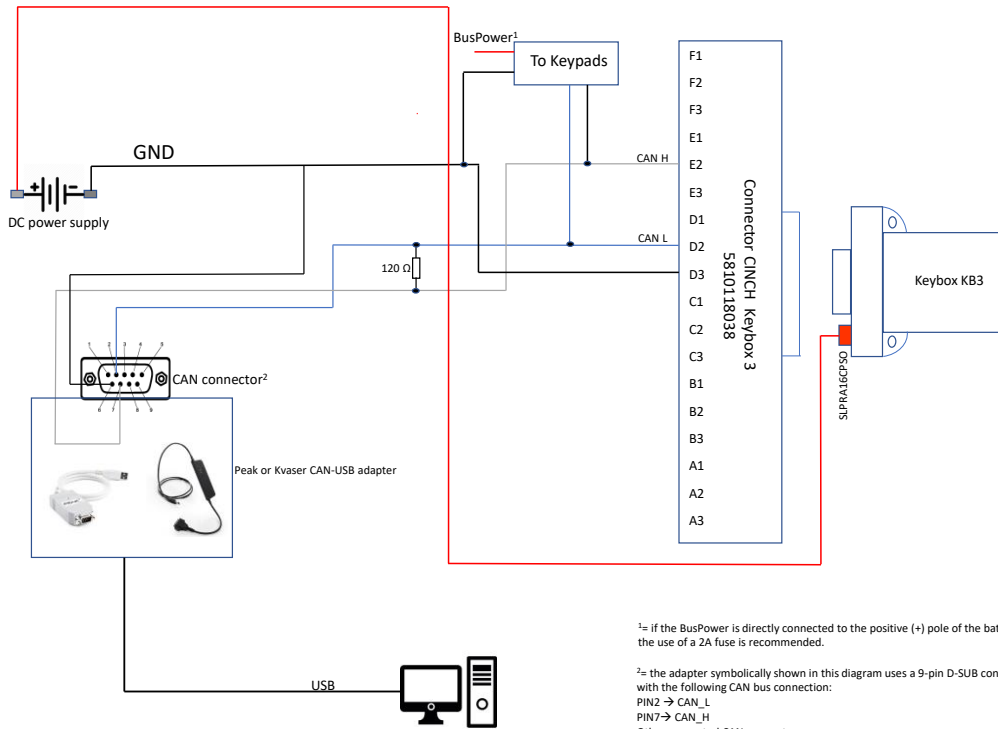

¹= if the BusPower is directly connected to the positive (+) pole of the battery, the use of a 2A fuse is recommended.

²= the adapter symbolically shown in this diagram uses a 9-pin D-SUB connector with the following CAN bus connection:
 PIN2 → CAN_L
 PIN7 → CAN_H
 Other supported CAN connectors are:
 • 16-pin OBDII
 • 5-pin M12 Male
 • 9-pin J1939-13 Type I or II
 See the related pinout for the CAN bus connection.

USB to RS485 interface

Figure 2

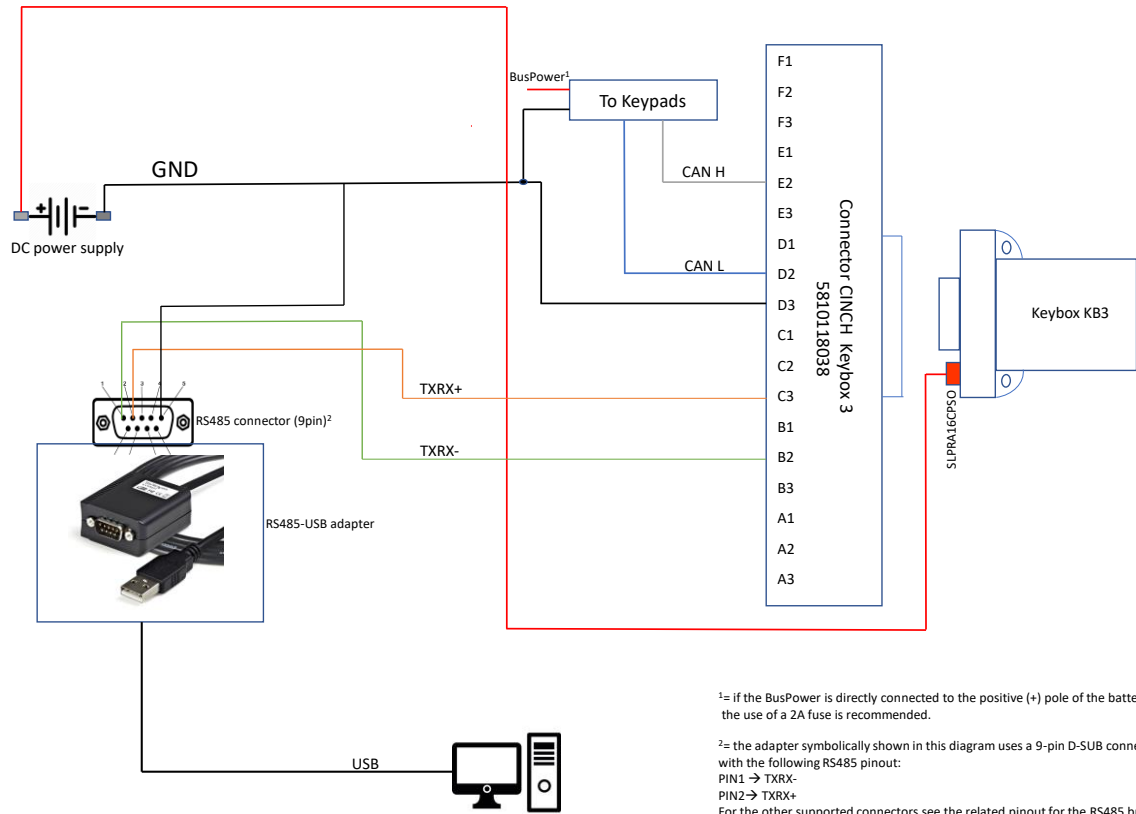

¹= if the BusPower is directly connected to the positive (+) pole of the battery, the use of a 2A fuse is recommended.

²= the adapter symbolically shown in this diagram uses a 9-pin D-SUB connector with the following RS485 pinout:
 PIN1 → TXRX-
 PIN2 → TXRX+
 For the other supported connectors see the related pinout for the RS485 bus connection.

Appendix: how to connect the Keybox to PC by the Blink RS485-USB adapter

1. With the wiring provided by Blink connect the AT06-2S connector and the USB cable to the matching connectors of the RS485-USB adapter.

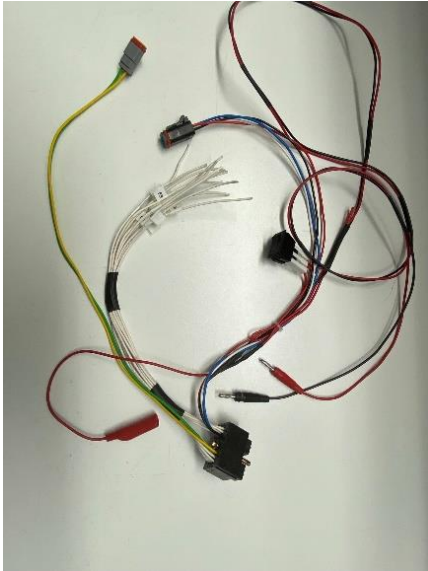

Wiring equipped with wires to test the outputs



RS485-USB adapter

2. Connect the USB cable to a USB port of the PC.

3. Connect the Cinch harness connector to the matching Cinch header connector on the Keybox.



4. Connect the banana plugs to a bench power supply and power up the system.

5. Using the *Keybox Configurator*, update the Keybox firmware, read or program the Keybox with the desired configuration as explained in the previous chapters.

Note: if the Keybox is programmed with a configuration that sets the D1 circuit as BUS Power, the switch on the wiring should be commuted in the '1' position (look at the image below) so that the keypads are supplied by the Keybox; otherwise, it should be commuted in '2' position so that the keypads are supplied by the external power supply.

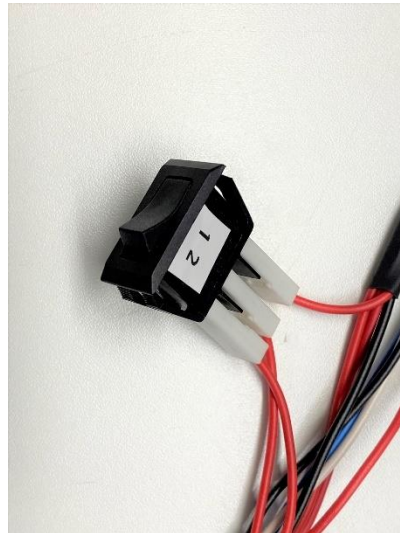

Switch

12. Revision history

Manual Revision	Comment	Related SW version
1.0	Preliminary version	1.1.2
1.1	New version: - Updated the menu icons images - Added the image of the PKP2500SI keypad model - Added chapter 11	1.1.9
1.2	Second version: - Updated chapter 9	1.2.2
1.3	Third version: - Updated chapters 4, 8, 10	1.2.2
1.4	Fourth version: - Added the keypad model PKP3500SI image in chapter 4	1.3.0
1.5	Fifth version: - Appendix: how to connect the Keybox to PC by the Blink RS485-USB adapter - Updated description of INPUT LEVEL COMMAND on pages 13 and 15	1.4.0
1.6	Sixth version: - Added picture and part number keypad/Keybox connector in the chapter 10	1.4.0
1.7	Seventh version: - Updated <i>keypad list</i> image on page 6 - Added note on page 9 - Added PKP1200LI reference image on page 12	1.6.0
1.8	Eighth version: - Added note on pages 21-23-26	1.6.0
1.9	Ninth version: - Updated function descriptions on pages 14-16	1.7.0